 **KENWOOD**

POWERED SUBWOOFER

**SW-300**

**INSTRUCTION MANUAL**

KENWOOD CORPORATION

©PRINTED IN U.S.A B61-0651-00 (TGN USA) (K, P)  
94/6 6 4 3

**Safety precautions**

# Introduction

Your choice of this product indicates that you are devoted to excellence in sound reproduction.

We appreciate your patronage and take pride in the long tradition of quality components that our company represents.

So that you can get the most out of your unit, we suggest that you take the time to read through this manual before you hook up and operate your system. This will acquaint you with operating features and system-connection considerations so that your listening pleasure will be enhanced right from the start. You will notice that in all aspects of planning, engineering, styling, operating convenience and adaptability we have sought to anticipate your needs and desires.

Keep this manual handy for future reference.

## For your records

Record the serial number, found on the back of the unit, in the spaces designated on the warranty card, and in the space provided below. Refer to the model and serial numbers whenever you call upon your dealer for information or service on this product.

Model SW-300 Serial Number \_\_\_\_\_

## Unpacking

Unpack the unit carefully and make sure that all accessories are put aside so they will not be lost.

Examine the unit for any possibility of shipping damage. If your unit is damaged or fails to operate, notify your dealer immediately. If your unit was shipped to you directly, notify the shipping company without delay. Only the consignee (the person or company receiving the unit) can file a claim against the carrier for shipping damage.

We recommend that you retain the original carton and packing materials for use should you transport or ship the unit in the future.

# Before applying power **⚠** Caution: Read this page carefully to ensure safe operation.

## For the U.S.A. and Canada

### Important!

Units shipped to the U.S.A. and Canada are designed for operation on 120 volts AC only.

**CAUTION** : TO PREVENT ELECTRIC SHOCK DO NOT USE THIS (POLARIZED) PLUG WITH AN EXTENSION CORD, RECEPTACLE OR OTHER OUTLET UNLESS THE BLADES CAN BE FULLY INSERTED TO PREVENT BLADE EXPOSURE.





## Contents

Caution : Read the pages marked **⚠** carefully to ensure safe operation.

Introduction .....	2	Connections .....	6
<b>⚠</b> Before applying power .....	2	Operation .....	9
<b>⚠</b> Safety precautions .....	3	Installation in a leg .....	10
<b>⚠</b> Important safeguards .....	3	Specifications .....	10
Installation .....	5		

## Safety precautions

**WARNING:** TO PREVENT FIRE OR SHOCK HAZARD, DO NOT EXPOSE THIS APPLIANCE TO RAIN OR MOISTURE.

 <b>CAUTION</b> RISK OF ELECTRIC SHOCK DO NOT OPEN		CAUTION: TO REDUCE THE RISK OF ELECTRIC SHOCK, DO NOT REMOVE COVER (OR BACK). NO USER-SERVICEABLE PARTS INSIDE. REFER SERVICING TO QUALIFIED SERVICE PERSONNEL.
		THE LIGHTNING FLASH WITH ARROWHEAD SYMBOL, WITHIN AN EQUILATERAL TRIANGLE, IS INTENDED TO ALERT THE USER TO THE PRESENCE OF UNINSULATED "DANGEROUS VOLTAGE" WITHIN THE PRODUCT'S ENCLOSURE THAT MAY BE OF SUFFICIENT MAGNITUDE TO CONSTITUTE A RISK OF ELECTRIC SHOCK TO PERSONS.
		THE EXCLAMATION POINT WITHIN AN EQUILATERAL TRIANGLE IS INTENDED TO ALERT THE USER TO THE PRESENCE OF IMPORTANT OPERATING AND MAINTENANCE (SERVICING) INSTRUCTIONS IN THE LITERATURE ACCOMPANYING THE APPLIANCE.

## IMPORTANT SAFEGUARDS

**⚠ Caution: Read this page carefully to ensure safe operation.**

Please read all of the safety and operating instructions before operating this appliance. Adhere to all warnings on the appliance and in the instruction manual. Follow all the safety and operating instructions. These safety and operating instructions should be retained for future reference.

- 1. Power sources** – The appliance should be connected to a power supply only of the type described in the instruction manual or as marked on the appliance. If you are not sure of the type of power supply to your home, consult your appliance dealer or local power company. For appliances intended to operate from battery power, or other sources, refer to the instruction manual.
- 2. Power-cord protection** – Power-supply cords should be routed so that they are not likely to be walked on or pinched by items placed upon or against them, paying particular attention to cords at plugs, convenience receptacles, and the point where they exit from the appliance.

Never pull or stretch the cord.



- 3. CAUTION – Polarization** – This appliance may be equipped with a polarized alternating-current line plug (a plug having one blade wider than the other). This plug will fit into the power outlet only one way. This is a safety feature. If you are unable to insert the plug fully into the outlet, try reversing the plug. If the plug should still fail to fit, contact your electrician to replace your obsolete outlet. Do not defeat the safety purpose of the polarized plug.
- 4. Ventilation** – Slots and openings in the cabinet are provided for ventilation and to ensure reliable operation of the appliance and to protect it from overheating, and these openings must not be blocked or covered. The appliance should be situated so that its location or position does not interfere with its proper ventilation.

To maintain good ventilation, do not put records or a tablecloth on the appliance. Place the appliance at least 10 cm away from the walls. Do not use the appliance on a bed, sofa, rug or similar surface that may block the ventilation openings. This appliance should not be placed in a built-in installation such as a bookcase or rack unless proper ventilation is provided or the manufacturer's instructions have been adhered to.

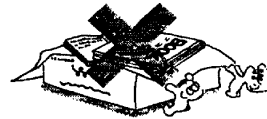

- 5. Suffocation** – After taking the unit out of the polyethylene bag, be sure to dispose of the polyethylene bag out of the reach of children. Otherwise, they may play with the bag, which could cause hazard of suffocation.



- 6. Water and moisture** – The appliance should not be used near water - for example, near a bathtub, washbowl, kitchen sink, laundry tub, in a wet basement, or near a swimming pool, etc.
- 7. Temperature** – The appliance may not function properly if used at extremely low, or freezing temperatures. The ideal ambient temperature is above +5°C (41°F).
- 8. Heat** – The appliance should be situated away from heat sources such as radiators, heat registers, stoves, or other appliances (including amplifiers) that produce heat.

Note:  
Item 3 is not required except for grounded or polarized equipment.

SW-300 (En) 3

**⚠ Caution: Read this page carefully to ensure safe operation.**

- 9. Electric shock** – Care should be taken so that objects do not fall and liquid is not spilled into the enclosure through openings. If a metal object, such as a hair pin or a needle, comes into contact with the inside of this appliance, a dangerous electric shock may result. For families with children, never permit children to put anything, especially metal, inside this appliance.

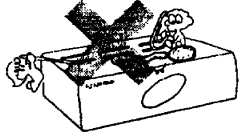

- 10. Enclosure removal** – Never remove the enclosure. If the internal parts are touched accidentally, a serious electric shock might occur.

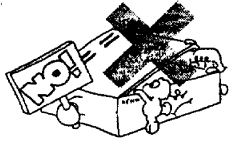

- 11. Magnetic fields** – Keep the appliance away from sources of magnetic fields such as TV sets, radios, motorized toys or magnetized objects:

- 12. Cleaning** – Unplug this appliance from the wall outlet before cleaning. Do not use volatile solvents such as alcohol, paint thinner, gasoline, or benzine, etc. to clean the cabinet. Use a clean dry cloth.

- 13. Accessories** – Do not place this appliance on an unstable cart, stand, tripod, bracket, or table. The appliance may fall, causing serious injury to a child or adult, and serious damage to the appliance. Use only with a cart, stand, tripod, bracket, or table recommended by the manufacturer, or sold with the appliance. Any mounting of the appliance should follow the manufacturer's instructions, and should use a mounting accessory recommended by the manufacturer. An appliance and cart combination should be moved with care. Quick stops, excessive force, and uneven surfaces may cause the appliance and cart combination to overturn.



- 14. Lightning** – For added protection for this appliance during a lightning storm, or when it is left unattended and unused for long periods of time, unplug it from the wall outlet and disconnect the antenna or cable system. This will prevent damage to the appliance due to lightning and power-line surges

- 15. Abnormal smell** – If an abnormal smell or smoke is detected, immediately turn the power OFF and unplug the appliance from the wall outlet. Contact your dealer or nearest service center.

### POWER OFF!



- 16. Damage requiring service** – The appliance should be serviced by qualified service personnel when:

- A. The power-supply cord or the plug has been damaged.
- B. Objects have fallen, or liquid has been spilled into the appliance.
- C. The appliance has been exposed to rain or water.
- D. The appliance does not appear to operate normally by following the instruction manual. Adjust only those controls that are covered by the instruction manual as an improper adjustment of other controls may result in damage and will often require extensive work by a qualified technician to restore the appliance to its normal operation.
- E. The appliance has been dropped, or the enclosure damaged.
- F. The appliance exhibits a marked change in performance.

- 17. Servicing** – The user should not attempt to service the appliance beyond that described in the instruction manual. All other servicing should be referred to qualified service personnel.

- 18. AC outlets** – Do not connect other audio equipment with a power consumption larger than that specified to the AC outlet on the rear panel. Never connect other electrical appliances, such as an iron or toaster, to it to prevent fire or electric shock.

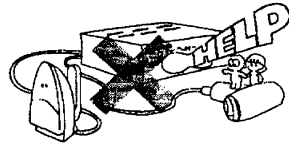

- 19. Overloading** – Do not overload wall outlets, extension cords, or integral convenience receptacles as this can result in a risk of fire or electric shock.

- 20. Attachment** – Do not use attachments not recommended by the appliance manufacturer as they may cause hazards.

- 21. Replacement parts** – When replacement parts are required, be sure the service technician has used replacement parts specified by the manufacturer or have the same characteristics as the original parts. Unauthorized substitutions may result in fire, electric shock, or other hazards.

- 22. Safety check** – Upon completion of any service or repairs to this appliance, ask the service technician to perform safety checks to determine that the appliance is in proper operating condition.

# Installation

The Subwoofer is a virtually omnidirectional speaker, so it can be installed in almost any location. For example, the Subwoofer can be installed next to the component system (consisting of an amplifier, tuner, cassette deck, etc.), or in a corner of the room, etc. The subwoofer's deep bass reproduction characteristics are richest when the subwoofer is installed in a corner or near a wall. Since the low bass component in music is usually monaural, only one subwoofer is necessary to obtain a sufficient stereo effect when used in combination with a stereo music system.

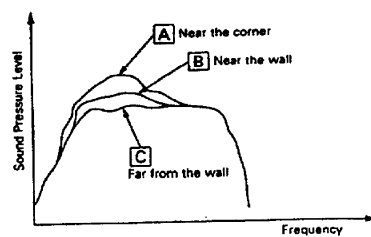
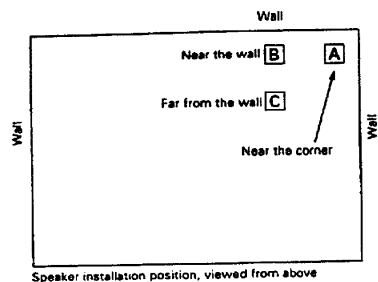

## ■ Howling

If the Subwoofer is installed near an analog record turntable, a howling sound may be generated. If this occurs, place the Subwoofer farther away from the turntable or reduce the Subwoofer VOLUME (By rotating the volume control counterclock-wise). The howling phenomenon may also occur due to cross interference with a cassette deck, compact disc player, or Laserdisc player, although this is very rare. If sound or picture seems to be distorted due to this reason, place the Subwoofer farther away from other components or reduce its volume.

SW-300 (En) 5

2/2

■ If the amplifier is not equipped with a

CAUTION: When connecting the Subwoofer to the amplifier, be sure to always

## Connections

### Before connection:

1. Set the POWER switches of the amplifier and Subwoofer to OFF. If they are connected with the POWER switch(es) left ON, one or both of them may be damaged.

■ If the amplifier is equipped with a Subwoofer Pre-Out jack

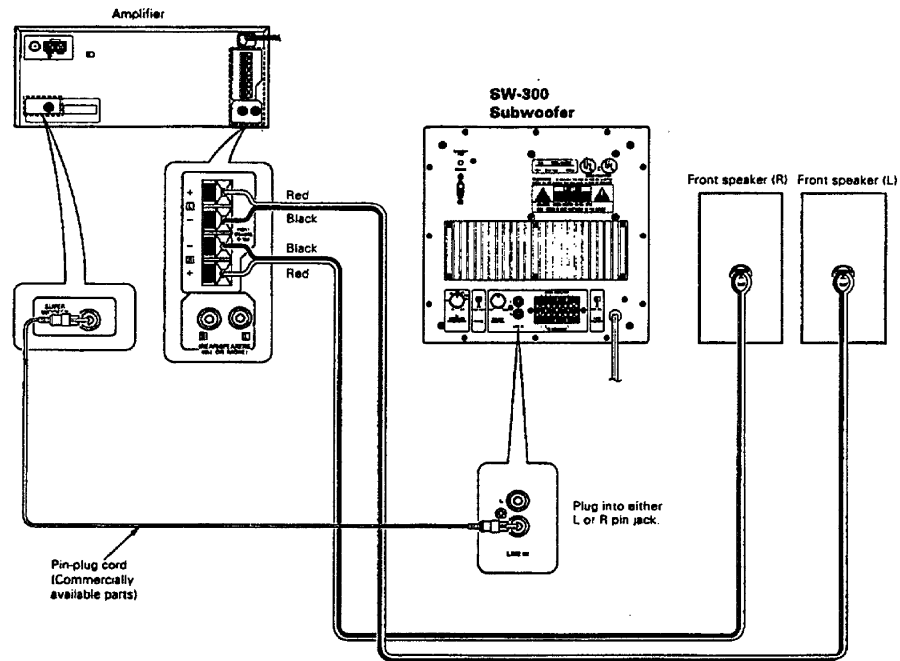

2/2

■ If the amplifier is not equipped with a Subwoofer Pre-Out jack

**CAUTION:**  
When connecting the Subwoofer to the amplifier, be sure to always connect the "+" terminals to "+" terminals and "-" terminals to "-" terminals. If terminals are connected incorrectly, the amplifier may be damaged.

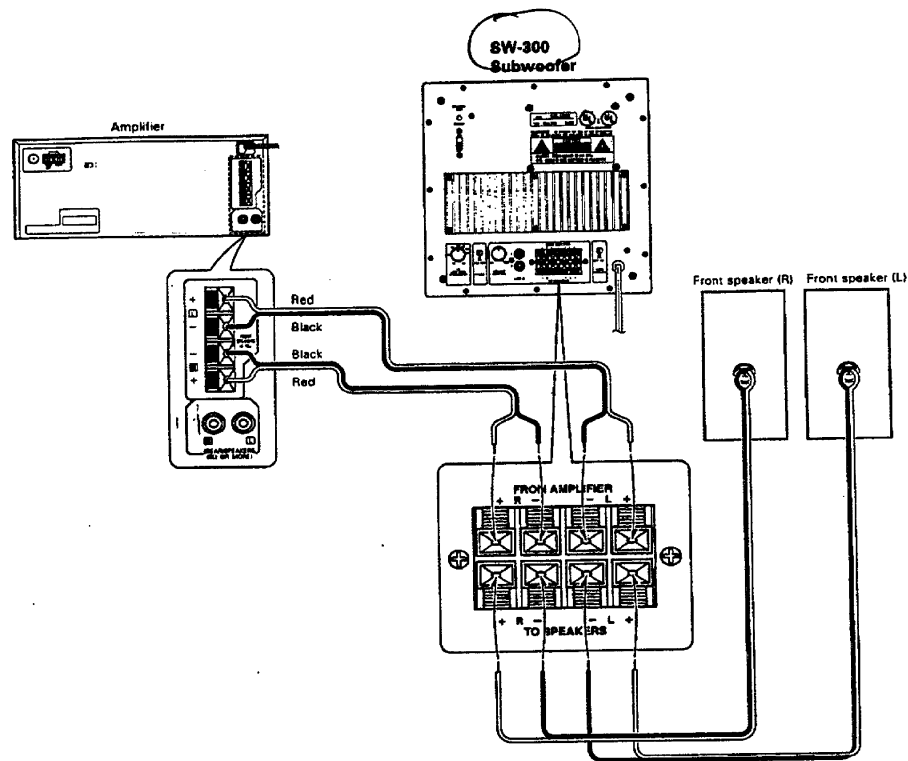

SW-300 (EN) 7

# Operation

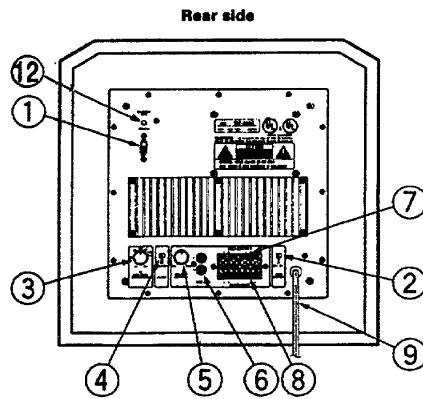
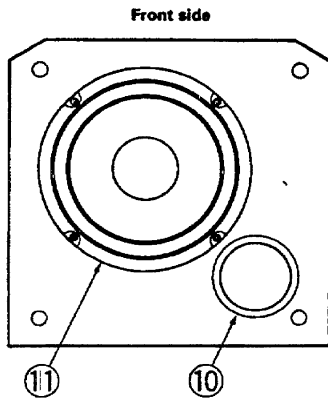

**① POWER switch**

Switches the power ON and OFF.

**② AUTO SHUTOFF switch**

By setting and leaving both the POWER and AUTO SHUTOFF switches in the ON positions, power is switched ON automatically when a signal is applied to an input (either HIGH LEVEL INPUT or LOW LEVEL INPUT).

**③ LOW PASS CROSSOVER knob**

Adjusts the balance between the bass from the front speakers and the bass from this unit (SW-300).

**④ PHASE switch**

Switches the speaker sound phase to vary the tonal quality of the bass.

**⑤ VOLUME CONTROL**

Adjusts the volume level of the output of the Subwoofer. Rotating the knob clockwise increases the volume level, and rotating the knob counterclockwise decreases the volume level.

**⑥ LINE IN jack (RCA-type pin-plug)**

These jacks are used to connect the Subwoofer Pre-Out jacks of the amplifier.

**⑦ FROM AMPLIFIER terminals**

These terminals are used to connect the FRONT SPEAKER terminals of the amplifier to this unit.

**⑧ TO SPEAKERS terminals**

These terminals are used to connect the front speakers with this unit using speaker cables.

**⑨ Power cord**

Connect to a 110-120 V AC power outlet.

**⑩ Duct**

Extends low-frequency output.

**⑪ Loudspeaker**

**⑫ STANDBY indicator**

This indicator indicates the standby mode when it lights in red and the operation mode of the amplifier when it lights in green. When the AUTO POWER switch is set to ON, the amplifier is set automatically to the standby mode when no signal has been input to the amplifier for 7 minutes.

**■ How to use the VOLUME CONTROL, LOW PASS CROSSOVER knob, and PHASE switch**

The VOLUME CONTROL, FREQUENCY knob and PHASE switch can be adjusted to match the condition of the listening room and/or the characteristics of the left and right front speakers.

When the LOW PASS CROSSOVER knob is set to the 80 Hz or 200 Hz positions, install the Subwoofer between the left and right speakers to obtain a better sound field effect.

**Typical Control Positions**

FRONT SPEAKER	LOW PASS CROSSOVER	PHASE	VOLUME
Large speaker	50-60 Hz	NORMAL	○
Medium speaker	80-100 Hz	NORMAL	○
Small speaker	120-200 Hz	NORMAL	○

**■ Caution concerning operation**

An excessive input level to the Subwoofer may impair the sound quality or damage the unit. Careful attention should therefore be paid to the following precautions.

**Note:**

1. Do not increase the output of the amplifier to a high level while the low-frequency level is enhanced by the amplifier's tone control or loudness control.
2. When operating the amplifier switches or when placing the stylus on an analog record, set the amplifier volume to its minimum level.





